

L'éducatrice en Folie



Thème de l'espace

- ♥ 5 fiches d'activités
- ♥ 1 coloriage
- ♥ 1 jeu de manipulation
- ♥ 1 bricolage

Idéal pour les enfants de 2 à 5 ans. Amusez-vous bien!

L'espace - Coloriage

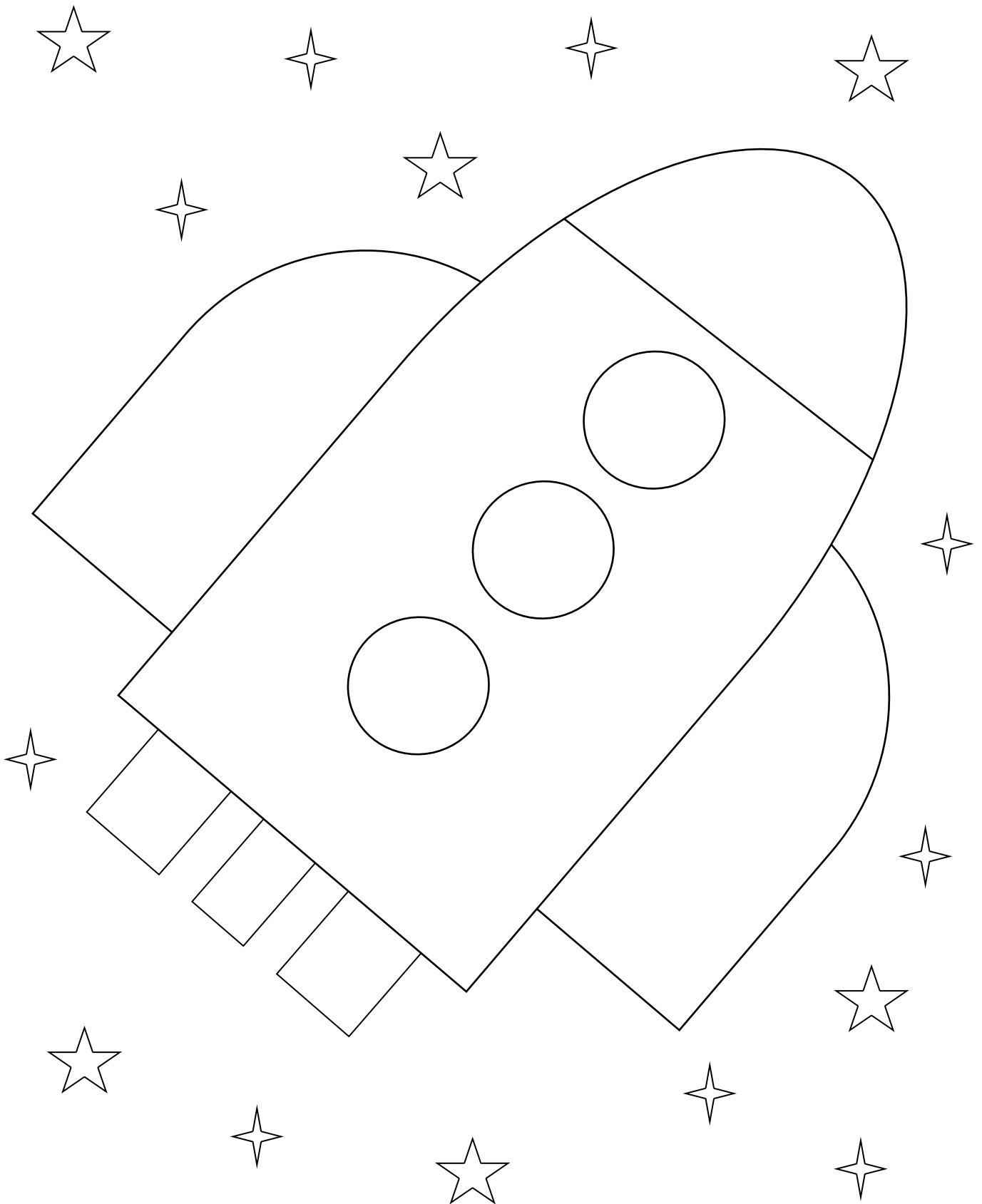

L'espace - Activité artistique

Colle des étoiles autocollantes
(sticker) dans l'espace autour de
la planète.

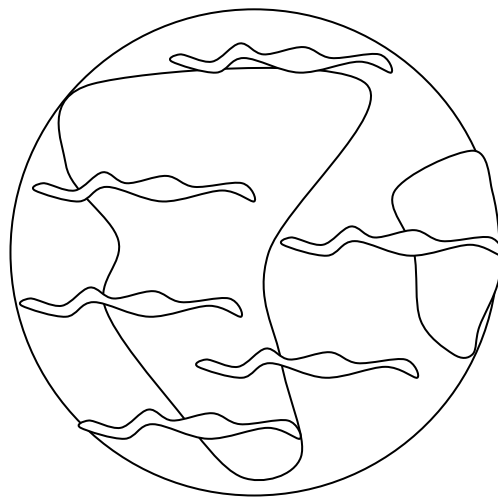

Bravo champion, championne,
tu mérites ces étoiles pour ton
travail !

L'espace - Activité de graphisme

Trace le chemin entre la fusée et
l'extraterrestre (peinture aux doigts)

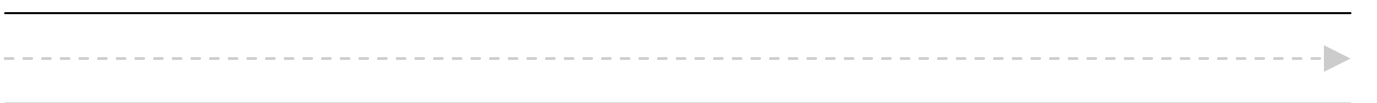
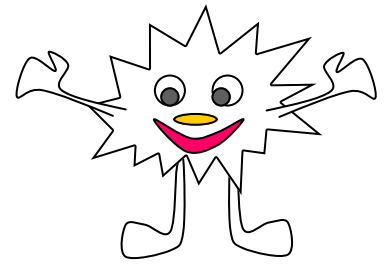
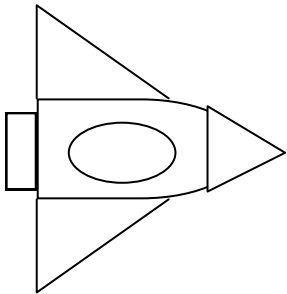
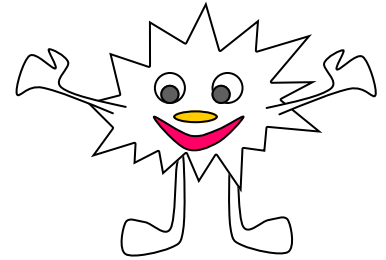
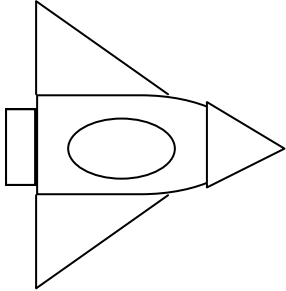

Bravo champion, championne,
tu mérites ces étoiles pour ton
travail !

L'espace - Activité mathématique

Regroupe les étoiles en
paquet de 3

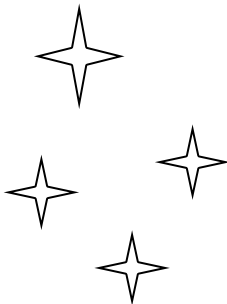
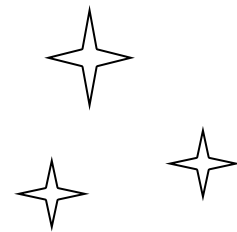
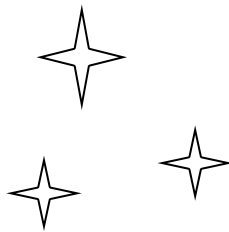
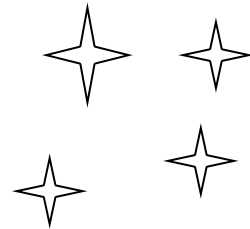
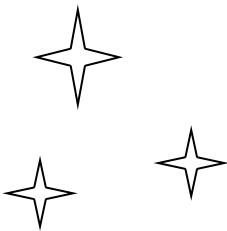
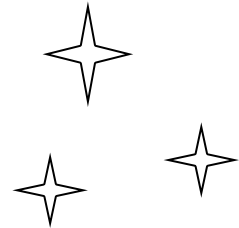
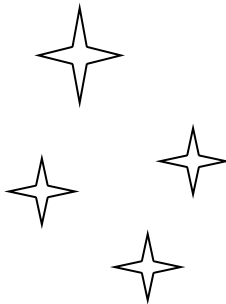
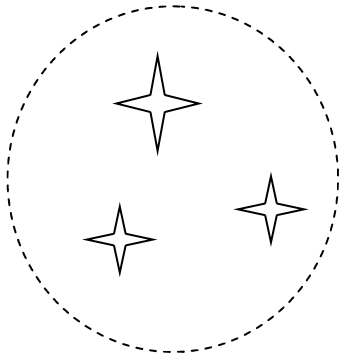

Bravo champion, championne,
tu mérites ces étoiles pour ton
travail !

L'espace - Activité mathématique

Colorie en « **rouge** » les
grandes fusées et en
« **bleu** » les petites.

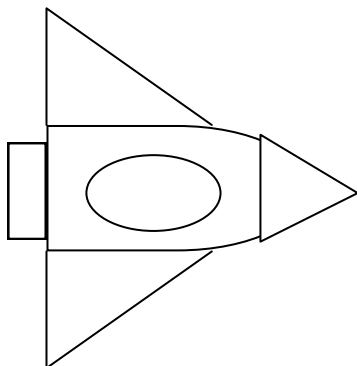
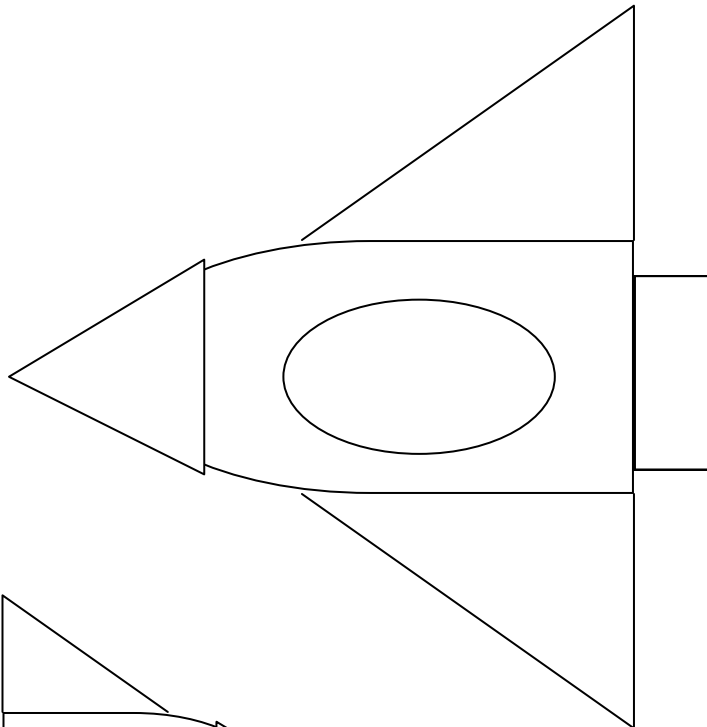
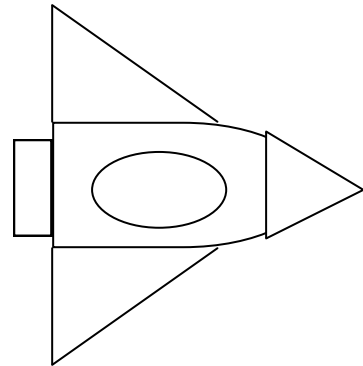
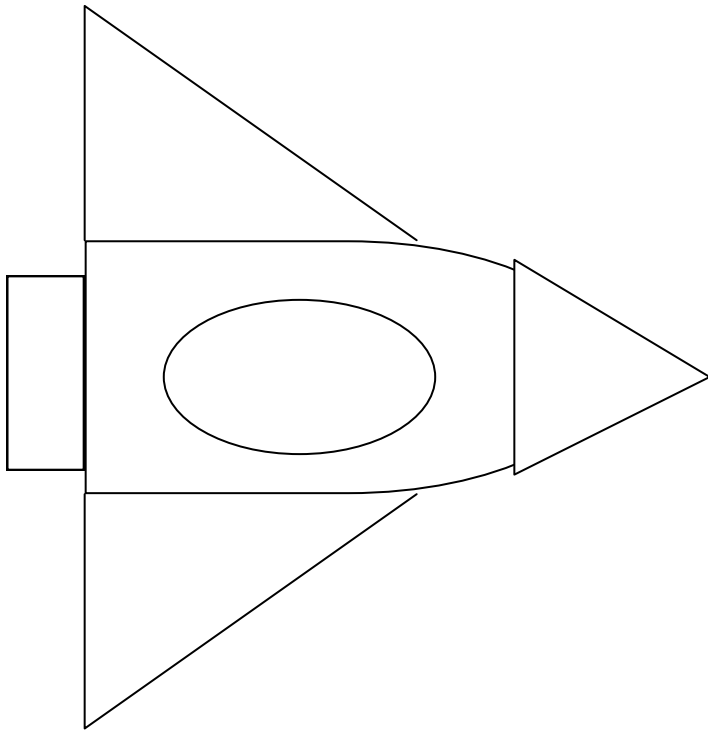

Bravo champion, championne,
tu mérites ces étoiles pour ton
travail !

L'espace

Une fusée, en formes géométriques.

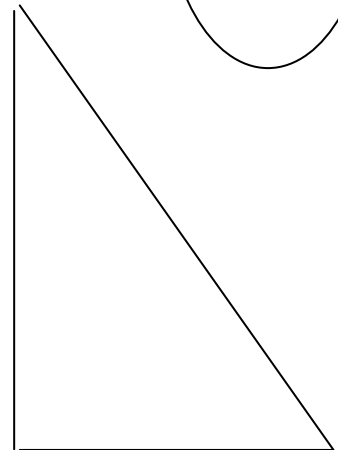
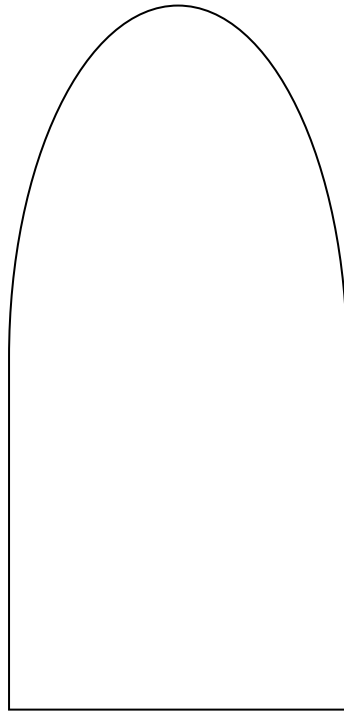
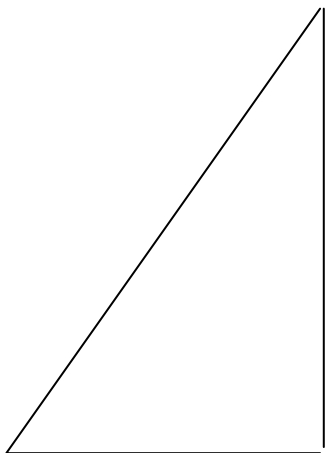
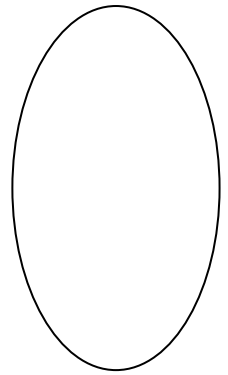
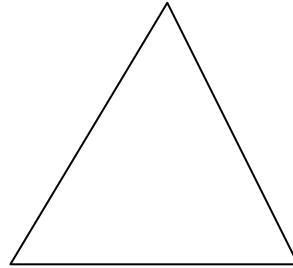
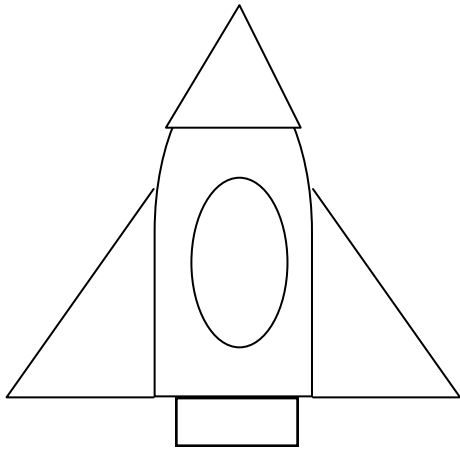

L'espace - Jeu de mémoire

Découpez les cartes et
jouez

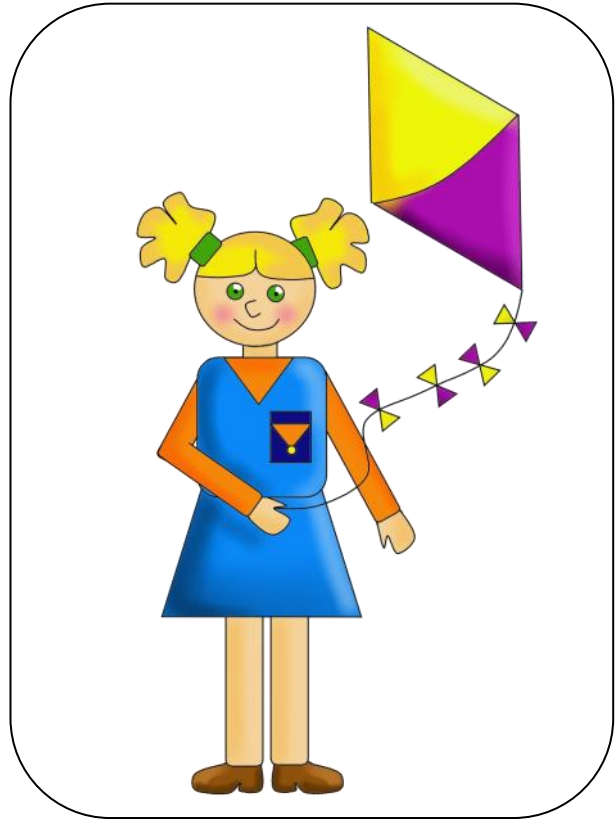
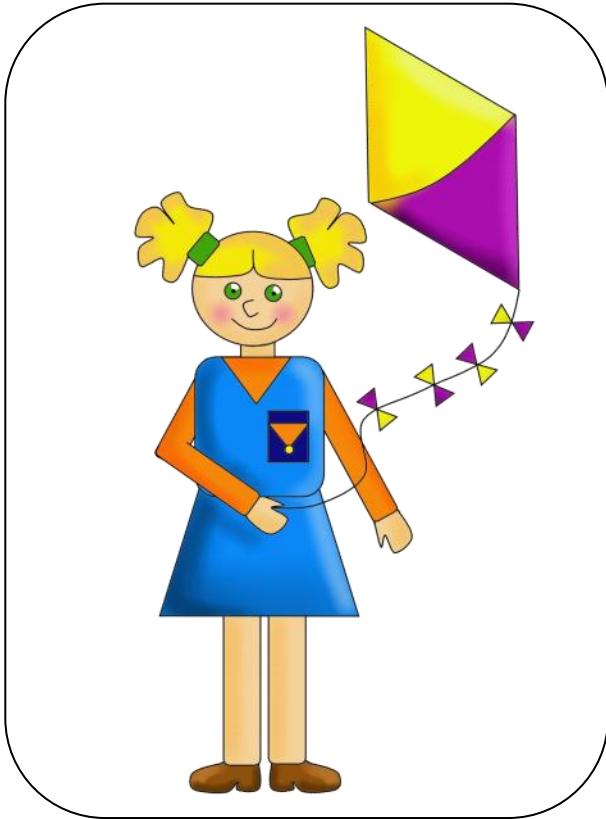

L'espace - Jeu de mémoire

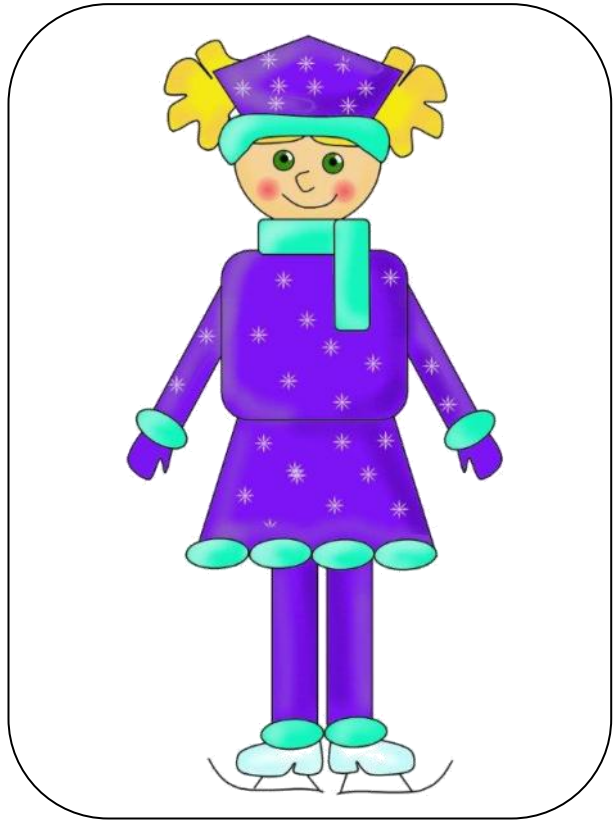

L'espace - Bricolage

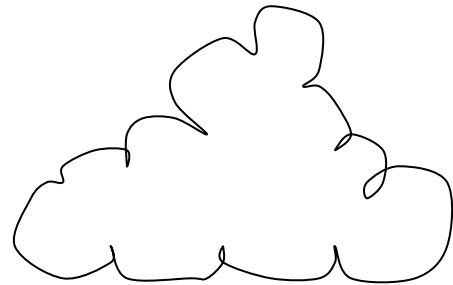
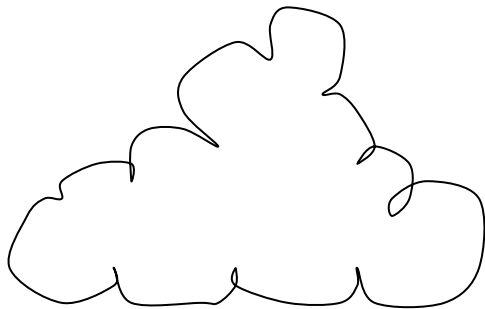
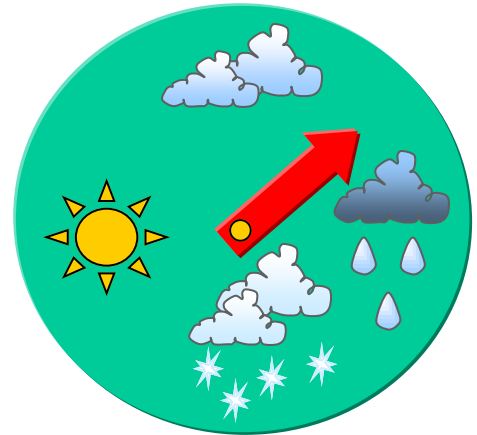
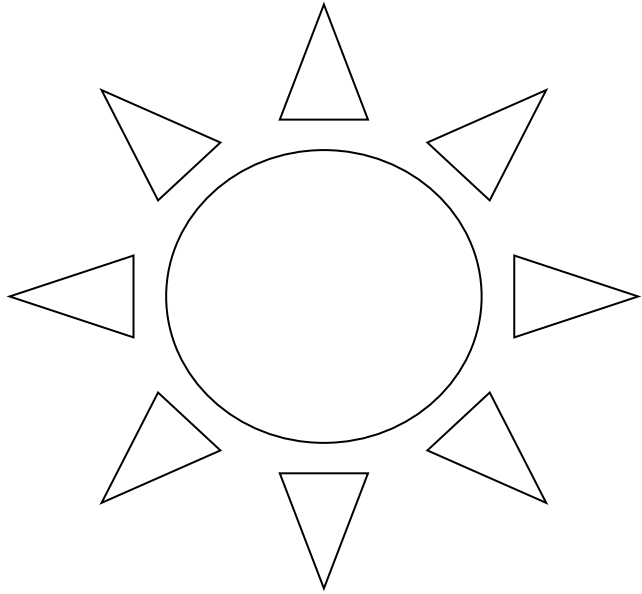

Bricolage : *Assiette météo*

1. Peindre l'assiette de la couleur de ton choix.
2. Coller le soleil.
3. Coller les nuages.
4. Découper flocons et la flèche.
5. Placer l'attache parisienne sur la flèche, au milieu de l'assiette.
6. Décorer l'assiette.